

DCM-270BAH-OS

Item # _____

Project: _____

Qty: _____

*AutoCad available on KCL

OPTI-SERVE SERIES SANITARY CUBELET ICE MACHINE/DISPENSER

DCM-270BAH-OS

2/14

Item #13159

DIMENSIONS W x D x H

DCM-270BAH-OS

16^{9/16} x 24^{1/8} x 31^{11/16}*
*with 4" legs

SD-270

16^{1/2} x 24 x 35^{3/16}

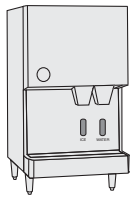

DCM-270



SD-270
optional
stand



*Hands-free sensor designed for use with opaque containers. Not intended for outdoor use - avoid placement in direct sunlight.

SD-270 door is reversible.

DCM-270BAH-OS

Air-Cooled
Shown on an optional
SD-270 Stand

DCM-270BAH-OS

- CleanCycle12® - Every 12 hours, unit performs 15 minute purge to rid itself of impurities
- LED Remote sensor for hands-free operation
- Sealed LED housing prevents moisture from entering, eliminating the possibility of an electrical short
- Durable stainless steel exterior
- Up to 288 lbs. of ice production per 24 hours
- Easy to chew, cubelet ice
- Self contained design reducing opportunities for cross contamination
- Dispenses ice and water
- Removable air filter
- Stainless steel internal auger
- R-404A Refrigerant
- Protected by H-GUARD Plus Antimicrobial Agent 



SD-270 Stand

- Heavy duty stand for floor model icemaker/dispenser
- Corrosion resistant stainless steel exterior
- Easy cleaning with attractive appearance
- Locking, reversible door

*CUBELET DIMENSIONS

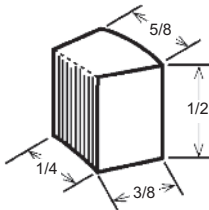

*approximate size in inches, image not to scale



ISO9001-15014/01

Warranty

Valid in United States, Canada, Puerto Rico, & U.S. Territories. Contact factory for warranty in other countries.

Three Year - Parts & Labor on entire machine. (Serial numbers VxxxxxJ and after.)

Five Year - Parts on: hermetic compressor, air-cooled fin and tube type condenser.

© HOSHIZAKI AMERICA, INC.

618 Hwy. 74 S., Peachtree City, GA 30269

TEL 1-800-438-6087

FAX 1-800-345-1325

www.hoshizaki.com



DCM-270BAH-OS SANITARY CUBELET ICE MACHINE/DISPENSER OPTI-SERVE SERIES

DIMENSIONS W x D x H

DCM-270BAH-OS
16^{9/16} x 24^{3/16} x 31^{7/8}
*with 4" legs
SD-270
16^{1/2} x 24 x 35^{3/16}

- Hands-free ice and water dispenser
- Optional stand with locking door

AIR-COOLED

Water Temp ° F.	50°	70°	90°	
Air Temp ° F.	70°	288	276	265
80°	254	243	233	
90°	224	220	205	

UTILITY CONSUMPTION

Model Number	KWH per 100 LBS.		GAL per 100 LBS.	
	90/70	70/50	90/70	70/50
DCM-270BAH-OS	7.3	5.3	12.0	12.0

SPECIFICATIONS

Model Number	Condenser	Amperage	Shipping Weight
DCM-270BAH-OS	Air-Cooled	8.5	166 lbs.
SD-270	N/A	N/A	89 lbs.

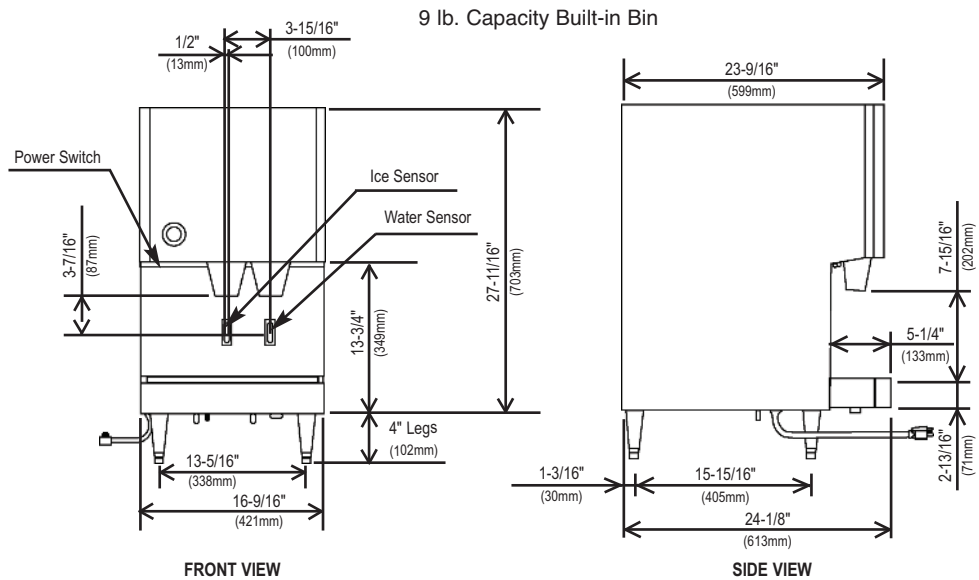

- Separate ICE and WATER Dispensing
- LED Remote Sensor for hands-free operation.

Flaked ice compacted into cubelets by extruding head cutter and stored in an insulated bin with continuous agitation during dispensing and direct dispensing auger

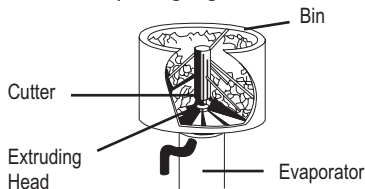

- Circuit breaker or fuse protects gear motor from overload.
- Gear motor runs one minute after termination of ice making to clear all ice from evaporator.

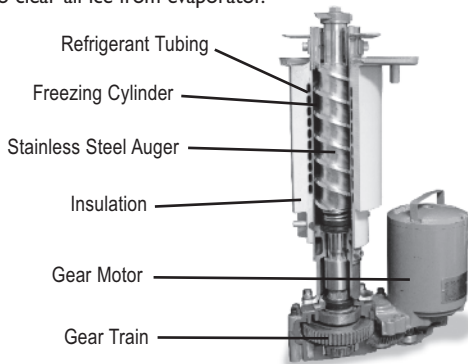

EVAPORATOR

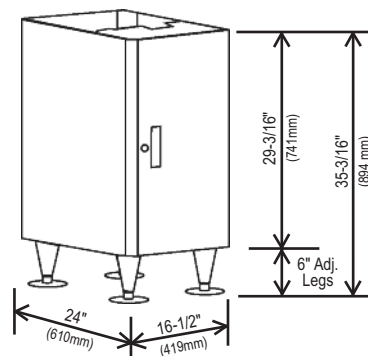

SD-270

ELECTRICAL & PLUMBING/DCM-270BAH-OS

- 115V/60/1
- 15 amp cord connection



150-2001-1501-4001

© HOSHIZAKI AMERICA, INC.

OPERATING LIMITS

- Ambient Temp Range 45 - 100°F
- Water Temp Range 45 - 90°F
- Water Pressure 10 - 113psig
- Voltage Range 104 - 127V

SERVICE

- Panels easily removed and all components accessible for service.
- Removable/cleanable air filter.

